

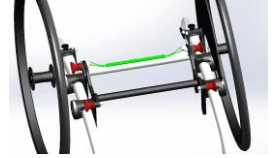



## Version

<input type="checkbox"/>		<input type="checkbox"/>	
<b>Original</b> Seat angle not adjustable back angle fixed in conjunction with basic backrest hinge adjustable in combination with RCA 1.0 or 1.5 backresthinge For an active sitting position		<b>Active (WorkHopper)</b> Seat angle and backrest angle adjustable only in combination with the RCA 1.0 or RCA1.5 backrest hinge For an Active sitting position	
Heavy Duty version max 150 kg		Not available in a Heavy Duty version	
Default		€ 1.569	
		Art : 131-000 X X	



## Removable seat unit

	
Removable seat unit *only available in Original version	
€ 586	
Art : 800-40129	

## Seat width (C)

<input type="checkbox"/>	34cm	<input type="checkbox"/>	36,5cm	<input type="checkbox"/>	39cm	<input type="checkbox"/>	41,5cm	<input type="checkbox"/>	44cm	<input type="checkbox"/>	46,5cm	<input type="checkbox"/>	49cm	<input type="checkbox"/>	51,5cm	Surcharge Heavy Duty Version
	Default		Default		Default		Default		Default		Default		Default		Default	
	Art : 800-40134		Art : 800-40136		Art : 800-40139		Art : 800-40141		Art : 800-40144		Art : 800-40146		Art : 800-40149		Art : 800-40151	
<input type="checkbox"/>	29cm	<input type="checkbox"/>	31,5cm					<input type="checkbox"/>	54cm	<input type="checkbox"/>	56,5cm	<input type="checkbox"/>	59cm	User weight from 120 kg		
	Upon request		Upon request						Upon request		Upon request		Upon request			
	Art : 800-40129		Art : 800-40131						Art : 800-40154		Art : 800-40156		Art : 800-40159	€ 525		

## Frame shape (Y)

<input type="checkbox"/>		<input type="checkbox"/>		<input type="checkbox"/>	
	U-shape		V8		Abduction
	Standaard		€ 208		€ 421
	Foot space = seat width - 10 cm		"Available from seat width 39cm Foot space = seat width - 15cm"		Foot space = seat width - 5cm
	Art : 800-40210		Art : 800-40220		Art : 800-40200

## Frame length (J)

<input type="checkbox"/>	34cm	<input type="checkbox"/>	40cm	<input type="checkbox"/>	45cm
	Recommended seat depth 37,5 - 42,5 cm		Recommended seat depth 42,5 - 50cm		Recommended seat depth 45 - 50cm
	Art : 800-40034		Art : 800-40040		Art : 800-40045

## brackets for transportation

<input type="checkbox"/>
€314 4 attachment points welded to the frame. Suitable for securing the wheelchair by means of 4-point strap system
Art : 200-20021





## Frame colour

<input type="checkbox"/>	matt Black RAL 9005	<input type="checkbox"/>	Speciaal - Uni
	Default		€ 277
	Specify desired RAL color at <a href="http://www.ralkleuren.com">www.ralkleuren.com</a>		
	Art : 800-40340		Art : 800-40350



## Camber (X)

<input type="checkbox"/>	0°	<input type="checkbox"/>	3°	<input type="checkbox"/>	6°
	Default		€ 54		€ 80
	Art : 800-40400		Art : 800-40403		Art : 800-40406

## Footrest (U)

Lower leg length adjustment range (at lowest front seat height of 47 cm with 24-inch drive wheels)						
<input type="checkbox"/>		<input type="checkbox"/>		<input type="checkbox"/>		
	Curved		Rectangular		Foldable 1 piece	
					"Foot space : minimum 24cm U-shape : from seat width 39cm V8 : from seat width 44cm	
	Default		Default		€ 250	
	Art : 200 - 38100		Art : 200 - 38200		Art : 200 - 38300	

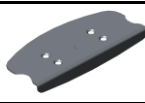

## Footplate

<input type="checkbox"/>		<input type="checkbox"/>		<input type="checkbox"/>		<input type="checkbox"/>	Costume made	<input type="checkbox"/>	Costume made
	Default ( 23 x 12cm ) Aluminum		Wide ( 29 x 12cm ) Aluminum		Deep ( 23 x 19cm ) Aluminum		Aluminum		Synthetic
			U-shape: from seat width 39cm V8: from seat width 44cm				Commissioned following drawing		
	Default		€ 102		€ 102		Upon request		
	Art : 800 - 38009		Art : 800 - 38010		Art : 800 - 38040		Art : 800 - 3801 x		Art : 800 - 3802 x



## Seat depth

<input type="checkbox"/>	37,5cm	<input type="checkbox"/>	40cm	<input type="checkbox"/>	42,5cm	<input type="checkbox"/>	45cm	<input type="checkbox"/>	47,5cm	<input type="checkbox"/>	50cm
											Not in combination with RCA1.5
	Art : 800-40537		Art : 800-40540		Art : 800-40542		Art : 800-40545		Art : 800-40547		Art : 800-40550

## Seating

<input type="checkbox"/>		<input type="checkbox"/>	
	Flat seat, expended metal, not in combination with RCA 1.0. For inlaycushion		Ergonomic contour seat cushion, padded
	€ 373		€ 628
	Art : 100-142 x x		Art : 100-122 x x



## Backrest hinge

<input type="checkbox"/>		<input type="checkbox"/>		<input type="checkbox"/>	
	Basis		RCA 1.0		RCA 1.5 i.c.m. external cushion
	Back Foldable back angle mechanically adjustable		Backrest-hinge centered		Backrest-hinge 2,5 cm rearpositioned
	(adjustment range 85 to 115 °)		By user manually per 3 ° adjustable (adjustment range 0 - 85 to 115 °) RCA = Remote Continuous Adjustable		
	Standaard		€ 984		€ 984
	Art : 100-38000		Art : 100-32000		Art : 100-36000



## Positie RCA Backrest hinge

<input type="checkbox"/>	Left on the frame	<input type="checkbox"/>	Right on the frame
	Art : 100-51030		Art : 100-51040



## Backrest shape

<input type="checkbox"/>	<input type="checkbox"/>	<input type="checkbox"/>
		
Straight	Ergonomic, anatomic backrest height from 40cm	Backrest for women, ergonomic, anatomic backrest height from 40cm
Standaard	€ 474	€ 612
Art : 100-225 x x	Art : 100-200 x x	Art : 100-220 x x

## Backrest height

<input type="checkbox"/>	<input type="checkbox"/>	<input type="checkbox"/>	<input type="checkbox"/>
			
Height 35cm	Height 40cm	Height 45cm	Height 50cm
Art : 800-42135	Art : 800-42140	Art : 800-42145	Art : 800-42150

## Kleur rughoes



<input type="checkbox"/>	<input type="checkbox"/>	<input type="checkbox"/>	<input type="checkbox"/>	<input type="checkbox"/>	<input type="checkbox"/>
					Reservehoes rugleuning
Red	Black	Dark blue	Yellow	BlueGreen	Color:
Default	Default	Default	Default	Default	€ 102
Art: 100-401 x x	Art: 100-402 x x	Art: 100-405 x x	Art: 100-407 x x	Art: 100-408 x x	Art: 100-40x x x

## Wheel diameter

For possible seating heights, we refer to our technical measuring sheet

<input type="checkbox"/>	<input type="checkbox"/>	<input type="checkbox"/>
24" + 1 - ( 25-540 )	25"	26" + 2 - (25 - 590 )
Default	€ 128	€ 128
Art: 800-41024	Art: 800-41025	Art: 800-41026

## Rear wheel (set, with Quick Release)

<input type="checkbox"/>	<input type="checkbox"/>	<input type="checkbox"/>	<input type="checkbox"/>
			Lichtgewicht Spinergy-wielen - Set
	Rear wheel with drumbrake (with black rim) only in 24", push handle recommended	Reinforced *Mandatory for Heavy Duty version	
Standaard	€ 1.197	€ 421	upon request
Art : 800-41024	Art : 991 - 42 x x x	Art : 991 - 2 X 202	Art : 991 - 43 x x x

## Éénhandaandrijving

Drive Left	<input type="checkbox"/>	Drive Right	<input type="checkbox"/>
			
One hand drive seat height 2 cm higher (front and back) not possible with 6° camber, only in 24"			
€ 1.772			
Art : 991 - 41 x x x			

## Rear tire

<input type="checkbox"/>	<input type="checkbox"/>	<input type="checkbox"/>	<input type="checkbox"/>	<input type="checkbox"/>
				
Schwalbe Marathon Plus Evolution - or conceivably good quality	Solid - PU	Schwalbe Right Run Red	Schwalbe Right Run Blue	Schwalbe Right Run Gray
Default	€ 91	€ 0	€ 0	€ 0
Art : 991-67 x 01	Art : 991-67 x 11	Art : 991-67 X 21	Art : 991-67 X 22	Art : 991-67 X 23

<input type="checkbox"/> Alber drives	
<input type="checkbox"/> E-Fix E35	<input type="checkbox"/> E-Motion
O4 Frame adaptation - € 105	
Delivered by dealer	

## Handrim (set)

<input type="checkbox"/>	<input type="checkbox"/>	<input type="checkbox"/>	<input type="checkbox"/>	<input type="checkbox"/>	CarboLife	
					<input type="checkbox"/>	<input type="checkbox"/>
Aluminum	TETRA	PARA	ERGO	Stainless steel	Gekko (each)	Curve L Tetra Grip (each)
Standaard	€ 458	€ 458	€ 500	€ 261	€ 266,00	€ 266,00
	Handrim with extra gripp	Handrim with extra gripp	Handrim with extra gripp			
Art : 800-62x11	Art : 800-62x01	Art : 800-62x02	Art : 800-62x03	Art : 800-62x12	Art : 991 : 624xx	Art : 991 : 624xx

## Spoke guard (set)

Set <input type="checkbox"/>		Set <input type="checkbox"/>	
	Transparant		O4-logo
	€ 208		€ 187
	Art : 991 - 60 x 01		Art : 991 - 60 x 02

## Breaks

<input type="checkbox"/>	Left	Right	<input type="checkbox"/>	<input type="checkbox"/>	Left	Right	<input type="checkbox"/>	<input type="checkbox"/>	Left	Right	<input type="checkbox"/>
Pull brake (pull to lock)		Push brake (push to lock)		Active brake		Default		€ 165		€ 165	
Art : 800-47103		Art : 800-47203		Art : 800-47104		Art : 800-47204		Art : 800-47106		Art : 800-47206	

<input type="checkbox"/>	Left	Right	<input type="checkbox"/>
Long push brake, folding (push to lock)		One-hand wheel brake (push to lock)	
€ 80		€ 80	
Art : 800 - 07105		Art : 800 - 07205	

<input type="checkbox"/>	Left	Right	<input type="checkbox"/>
One-hand wheel brake (push to lock)		One-hand wheel brake (push to lock)	
€ 399		€ 399	
Art : 800-47110		Art : 800-47110	

## Castor wheels (Set)



For possible seating heights, we refer to our technical measuring sheet

<input type="checkbox"/>	<input type="checkbox"/>	<input type="checkbox"/>
Soft 4" Synthetic	Hard 4" Synthetic	Hard 4" Aluminum
€ 59	€ 70	€ 155
Art : 800 - 04001	Art : 800 - 04002	Art : 800 - 04003



<input type="checkbox"/>	<input type="checkbox"/>	<input type="checkbox"/>
Hard 5" Synthetic	Hard 5" Synthetic	Hard 5" Aluminum
Default	€ 70	€ 155
Art : 800 - 05001	Art : 800 - 05002	Art : 800 - 05003

<input type="checkbox"/>
Soft 6" Synthetic
€ 59
Art : 800 - 06001



## Anti-tip

<input type="checkbox"/> Left  Right <input type="checkbox"/>	<input type="checkbox"/> Left  Right <input type="checkbox"/>	<input type="checkbox"/> Left  Right <input type="checkbox"/>
Anti-tip height adjustable	Tip-assist (step tube) fixed (not in combination with 2 anti-tip wheels)	Crutch holder
€ 165	€ 165	€ 112
Art : 800 - 44000	Art : 800 - 45000	Art : 800-43010
€ 123	€ 123	€ 112
Art : 800-43000	Art : 800-43500	Art : 800-43510



## Side guard

<input type="checkbox"/> Set 	<input type="checkbox"/> Set 	<input type="checkbox"/> Set 	<input type="checkbox"/>
Side guard, removable, no fender Only in combination with armrests	Side guard, fixed without fender, aluminum	Side guard, fixed with fender, carbon	Opening in Side guard fixed with fender, Carbon *Mandatory in combination with armrests
€ 133	€ 133	€ 399	€ 123
Art : 100 - 96030	Art : 100 - 96040	Art : 100 - 96010	Art : 100 - 96061



## Armrests



<input type="checkbox"/> Set 	<input type="checkbox"/> Set 
In height adjustable armrest, removable, angle fixed. Only when combined with Side guard fixed with fender, only carbon, the side guard will be adjusted. (additional cost)	In height adjustable armrest, removable, angle adjustable Only when combined with Side guard fixed with fender, only carbon, the side guard will be adjusted. (additional cost)
€ 399	€ 511
Art : 100 - 96110	Art : 100 - 96170



## Padding

<input type="checkbox"/> Links  Rechts <input type="checkbox"/>	<input type="checkbox"/> Links  Rechts <input type="checkbox"/>	<input type="checkbox"/> Links <input type="checkbox"/> Rechts <input type="checkbox"/>
Hemiplegie-arm cushioning (piece)	Arm cushioning long (piece) (Length as standard + 10cm)	Maatwerk
€ 250	€ 250	upon request
Art : 100 - 96140	Art : 100 - 96240	Art : 100 - 96130
€ 102	€ 102	Art : 100 - 96230
Art : 100 - 96180	Art : 100 - 96280	

## Accessoires

<input type="checkbox"/> 	<input type="checkbox"/> 	<input type="checkbox"/> 
Push handle, in height adjustable and removable	Headrest, in height adjustable and removable (Indicate measure A)	Push handle and Headrest in height adjustable and removable
€ 266	€ 266	€ 506
Art : 100 - 210 x x	Art : 100 - 230 x x	art.100-216 xx

<input type="checkbox"/> 1 Piece 	<input type="checkbox"/> 2 Pieces 
Tension strap for back, adjustable, out of Seat-E-Lastica, 5 cm wide <i>Not mounted</i>	Tension strap for back, adjustable, out of Seat-E-Lastica, 10 cm wide <i>Not mounted</i>
€ 75	€ 150
Art : 100 - 46001	Art : 100 - 46002
€ 75	€ 150
Art : 100 - 46011	Art : 100 - 46012

<input type="checkbox"/> 	<input type="checkbox"/> 
Incontinence cover	Extra Seating cover
€ 133	€ 133
Art : 100 - 112 x x	Art : 100 - 111 x x

<input type="checkbox"/>	<input type="checkbox"/>	<input type="checkbox"/>
		
<b>Calf band</b>	<b>Safety belt</b>	<b>Purse under the seat</b>
<b>€ 38</b>	<b>€ 102</b>	<b>€ 91</b>
<b>Art : 800 - 01001</b>	<b>Art : 800-01002</b>	<b>Art : 800 - 01010</b>

***The wheelchair has been crash tested and complies with ISO 7176-19 for transport in cab bus with a 4-point restraint system, fixed sitting in the wheelchair.***

**Fill out the form completely and send it to. : +31 (0) 315 396 909 (fax) or mail to [info@o4wheelchairs.com](mailto:info@o4wheelchairs.com)**

All our deliveries are subject to the General Conditions for the Supply of Mechanical, Electrical and Electronic Products (Orgalime S2000) as published by the Orgalime, The European Engineering Industries Association.

**O<sup>4</sup> Wheelchairs** Markenweg 9, 7051 HS Varsseveld, The Netherlands Phone: +31 (0) 315 396 900 E: [info@o4wheelchairs.com](mailto:info@o4wheelchairs.com) I: [www.o4wheelchairs.com](http://www.o4wheelchairs.com)